



### Pompe peristaltiche

Motore sincrono. Tubo Santoprene®. Connettore 4/6mm.  $\approx$  230 V/50 Hz~1.

### Peristaltic pumps

Synchronous motor. Santoprene® hose. Connector 4/6 mm.  $\approx$  230 V/50 Hz~1.

### Perisztaltikus szivattyúk

Szinkronmotor. Santoprene® tömlő. Csatlakozó 4/6 mm.  $\approx$  230 V/50 Hz~1.

📖	DESCR. / JEL.	Q (lph)	→↑↑ (mm)	⚡ (W)
U000001	Dosatech	1,8	210 × 95 × 80	4,5
U000002	SP-3000 (20 rpm)	3,0	120 × 75 × 90	

💡 anche disponibile con controller per 2-3-4 pompe / also available with controller for 2-3-4 pumps / 2-3-4 szivattyúhoz vezérlővel is kapható

### Pompe di dosaggio diaframma

Azionato da Solenoidi. Controllo manuale o esterno proporzionale. Connessione DN4 o DN6.  $\approx$  230 V/50 Hz~1.

### Diaphragm dosing pumps

Solenoid-driven. Proportional manual or external control. Connection DN4 or DN6.  $\approx$  230 V/50 Hz~1.

### Membrán adagolószivattyúk

Mágnesszelep által vezérelt. Arányos kézi vagy külső vezérlés. DN4 vagy DN6 csatlakozás.  $\approx$  230 V/50 Hz~1.



📖	DESCR.	Q / Q <sub>Pmax</sub> (lph)	P / P <sub>max</sub> (bar)	⚡ (W)	→↑↑ (mm)	Υ (kg)
U000120	LD 05	0,54 / 0,36	8 / 16	8	225 × 116 × 180	3,2
U000130	LD 1	1,1 / 0,76		13		
U000140	LD 2	2,3 / 1,9		19		
U000150	LD 4	3,8 / 3,4	25			
U000160	LD 6	6,8 / 6,2		4 / 8		
U000170	LD 10	10,0 / 9,0	3 / 6	22		
U000180	LD 15	15,3 / 13,0	1 / 3			

💡 anche disponibile / also available / is elérhető :  
- pompe pneumatiche a doppio diaframma / double diaphragm pneumatic pumps /  
dupla membrános pneumatikus szivattyúk  
- pompe lobo / lobe pumps / lebenyszivattyúk  
- pompe a girante flessibili / flexible impeller pumps / rugalmas járókerekes szivattyúk...

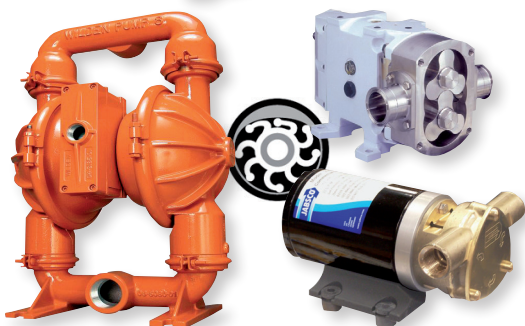

### Pompe di sentina

Sommersibile e resistente alla corrosione. Modelli standard con colino di base (nessuna staffa richiesta). Modello Aquacharge con batteria ricaricabile.

### Bilge pumps

Submersible and corrosion resistant. Rule models with base strainer (no bracket required). Aquacharge model running with rechargeable battery.

### Hajófenék-szivattyúk

Merülés- és korrózióálló. Szabványos modellek alapszűrővel (nincs szükség konzolra). Az Aquacharge modell újratölthető akkumulátorral működik.



📖	DESCR. / JEL.	Q1 / Q2 [*] (m³/h)	P <sub>max</sub> (mH <sub>2</sub> O)	⚡ (VDC)	⚡ (W)	Ø × ↑ (mm)	⊕ (mm)
U000201	Rule 360	1,4 / 1,0	3,7	12	23	60 × 89	19
U000205	Rule 500 [*]	1,9 / 1,4		12/24	34	73 × 102	
U000209	Rule 800 [*]	3,0 / 2,3					
U000213	Rule 1000	3,8 / 2,7		12	35	108 × 152	28
U000217	Rule 1100 [*]	4,2 / 3,2		12/24	40		
U000221	Rule 1500 [*]	5,7 / 4,5			58		
U000225	Rule 2000 [*]	7,6 / 6,1	6,4	12/24	101	124 × 184	38
U000229	Rule 3700 [*]	14 / 11	7,3		186		
U000233	Rule 4000 [*]	15 / 13		-		-	240 × 320
U000280	Aquacharge	≈ 1,0	-	-	-	-	-

[\*]: Q1 @ 0 mH<sub>2</sub>O / Q2 @ 1 mH<sub>2</sub>O [\*] opzione / option / választási lehetőség : AUTO.

anche disponibile : pompa LVM in linea e agitatore Tsunami / also available : LVM inline pump & Tsunami agitator / szintén kapható: LVM inline pump és Tsunami-keverő



### Pompe per acquario & stagno

Adatto per l'acqua di mare. Applicazione a secco o umida. Protezione da spegnimento automatico durante il funzionamento a secco. Quando la girante è bloccata, andrà in una posizione di "blocco" in cui la pompa non consuma energia e attende fino a quando il blocco non viene risolto. Questo eviterà che il motore si bruci. Serie Syncra con motore sincronico con magnete permanente. Serie DM con controller (flusso, fusi orari, on/off/pausa, wifi, ...). La serie DM è anche disponibile a velocità fissa e/o voltaggio basso ☞ pagina 173. Tutti i modelli DM : solidi fino a 6 mm. ⚡ 230 V/50 Hz~1.

### Aquarium & Pond pumps

Suitable for seawater. Dry or wet application. Automatic power-off protection when running dry. When the impeller is blocked it will go into a "lock" position in which the pump does not use power and waits until the blockage is gone. This will prevent a motor burn out. Syncra-series with permanent magnet synchronous motor. DM-series with controller (flow, time zones, on/off/pause, wifi, ...). DM-series also available with in fixed speed version and/or low voltage ☞ page 173. All DM models : solids up to 6 mm. ⚡ 230 V/50 Hz~1.

### Akvárium és tavi szivattyúk

Tengeri vízhez alkalmas. Száraz vagy nedves használat. Automatikus kikapcsolás elleni védelem szárazon futva. Amikor a járókerék blokkolva van, „retesztelt” helyzetbe kerül, amelyben a szivattyú nem használ áramot, és megvárja, amíg az elzáródás megszűnik. Ez megakadályozza a motor leégését. Szinkron sorozat állandó mágneses szinkron motorral. DM-sorozat vezérlővel (folyamat, időzónák, be/ki/szünet, wifi, ...). A DM sorozat rögzített sebességű változattal és / vagy alacsony feszültséggel is kapható ☞ 173. oldal (minden DM modell: szilárd anyag 6 mm-ig). ⚡ 230 V/50 Hz~1.



Icon	DESCR.	⚡ (W)	➔➔➔ (mm)	⊕ (mm)
Serie Syncra / Syncra-series / Syncra sorozat				
	U004759 Syncra Nano	3	58 × 43 × 46	½"
	U004767 Syncra 1.0	16	90 × 48 × 72	
	U004768 Syncra 1.5	23	103 × 60 × 78	¾"
	U004769 Syncra 2.0	32	123 × 85 × 105	
	U004771 Syncra 3.0	45	173 × 99 × 118	1"
	U004773 Syncra 4.0	80		
	U004774 Syncra 5.0	105	160 × 288 × 170	1" ½
	U004776 Syncra 10	135		
	U004778 Syncra 12	155	160 × 290 × 170	1" ½
	U004780 Syncra 16	175		
Serie DM-Vario / DM-Vario series / DM-Vario sorozat				
	U000610 DM-10	85	190 × 105 × 130	2"
	U000620 DM-20	130	215 × 126 × 155	
	U000625 DM-25	360	275 × 125 × 160	
	U000630 DM-30	450	355 × 125 × 175	
	U000635 DM-35	360	400 × 300 × 200	3"
	U000640 DM-40	450		
	U000650 DM-50	600		

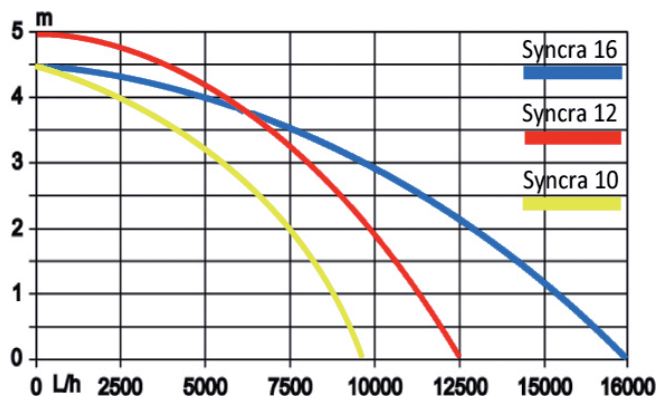
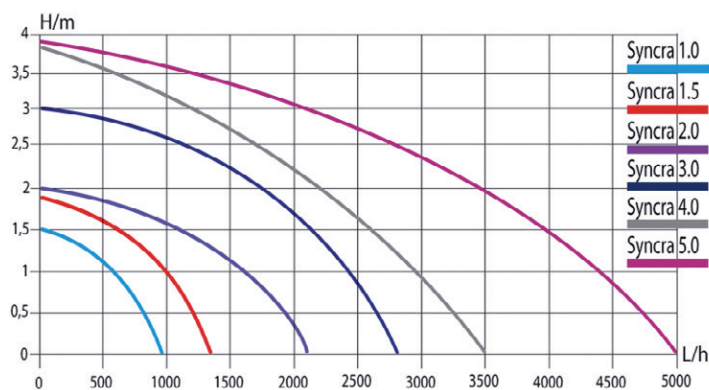
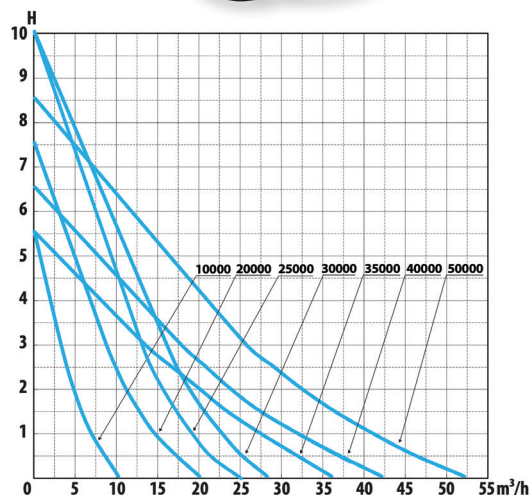

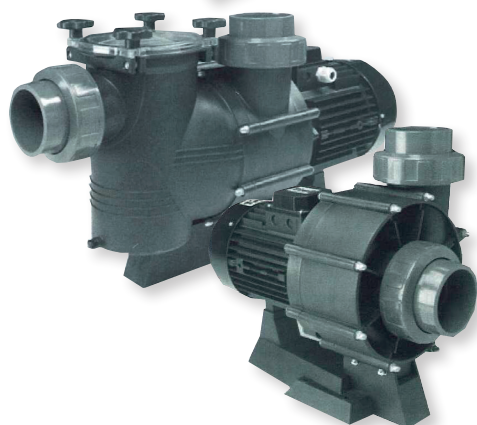

### Pompe da piscina

Autoadescante (eccetto Hermes & Atlas). Adatta all'acqua di mare. Corpo termoplastico, Girante in Noryl o bronzo (Atlas), albero in acciaio inossidabile.

### Pool pumps

Self-priming (except Hermes & Atlas). Suitable for seawater. Thermoplastic body, Noryl or bronze (Atlas) impeller, stainless steel shaft.

### Medence szivattyúk

Önindító (az Hermes & Atlas kivételével). Tengeri vízhez alkalmas. Hőre lágyuló test, Noryl vagy bronz (Atlas) járókerék, rozsdamentes acél tengely.

Modelli piccoli e standard / Small & standard models / Kicsi és standard modellek					
☑ 230 V~1	☑ 400 V~3	⚡ (kW)	→↑↑ (mm)	℥ (kg)	⊕ (mm)
Serie Mini / Mini-series / Mini sorozat					
U300300		0,20	438 × 199 × 260	8	50
U300310	-	0,25			
U300320		0,37			
U300340		0,55			
Serie Hermes senza prefiltro / Hermes-series without prefilter / Hermes sorozat előszűrő nélkül					
U300400		0,20	285 × 165 × 206	6	38
U300410	-	0,25			
U300420		0,37			
Serie Europa / Europa-series / Europa sorozat					
U300000	U300100	0,37	545 × 290 × 335	12	2" / 63
U300010	U300110	0,55			
U300020	U300120	0,75			
U300030	U300130	1,1	570 × 290 × 335	17	
U300040	U300140	1,5	585 × 290 × 335	19	
U300060	U300160	2,2	605 × 290 × 335	22	
Serie Argonaut AG / Argonaut AG-series / Argonaut AG sorozat					
U400110		0,19	477 × 195 × 276	7,7	50
U400120	-	0,25			
U400130		0,37			
U400140		0,49			
Serie Argonaut AV / Argonaut AV-series / Argonaut AV sorozat					
U400210	U400310	0,24	548 × 198 × 311	13	63
U400220	U400320	0,37			
U400230	U400330	0,55			
U400240	U400340	0,75	578 × 198 × 311	18	
U400250	U400350	1,10			
U400260	U400360	1,50			

Modelli ad alto flusso / High-flow models / Nagy átfolyású modellek [*]					
☑ ○	☑ ☐	⚡ (kW)	→↑↑ (mm)	℥ (kg)	⊕ (mm)
Serie Discovery / Discovery-series / Serie Discovery					
-	U300500	2,2	713 × 264 × 431	24	90 / 75
	U300510	2,9	743 × 264 × 431	27	
	U300520	4,0		29	
Serie Atlas / Atlas-series / Atlas sorozat					
U248238	U248228	2,9	510 / 820 × 330 × 470	39/46	90
U248239	U248229	4,0	530 / 840 × 330 × 470	44/51	110
U248235	U248232	5,5			
U248236	U248233	7,4		600 / 910 × 330 × 470	
U248237	U248234	9,2	645 / 955 × 330 × 470	65/72	
Serie Danubi / Danubi-series / Danubi sorozat					
U300601	U300600	5,5	815 / 1215 × 550 × 653	-	150 / 250
U300611	U300610	7,4	850 / 1250 × 550 × 653		
U300621	U300620	11,2	950 / 1350 × 550 × 653		

[\*]: ⚡ 400 V / 50 Hz~3

○ : senza prefiltro / without prefilter / előszűrő nélkül

☐ : con prefiltro / with prefilter / előszűrővel

⚡ : velocità variabile su richiesta / frequency converter on request / igény szerint változtatható sebesség

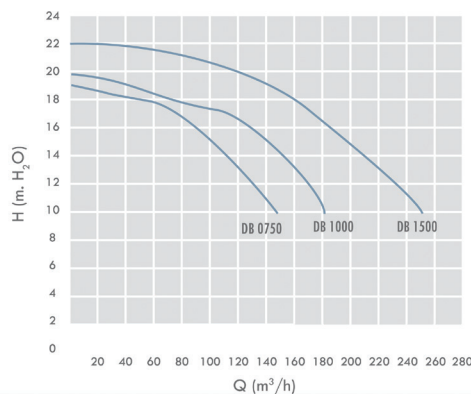
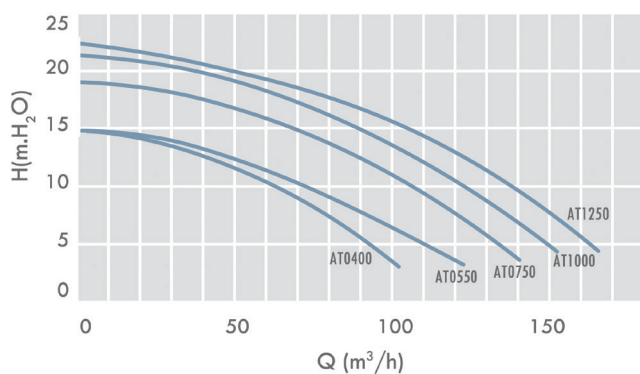
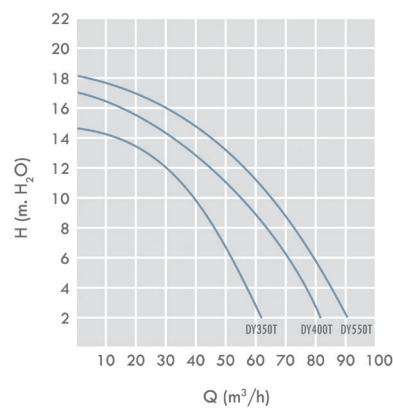
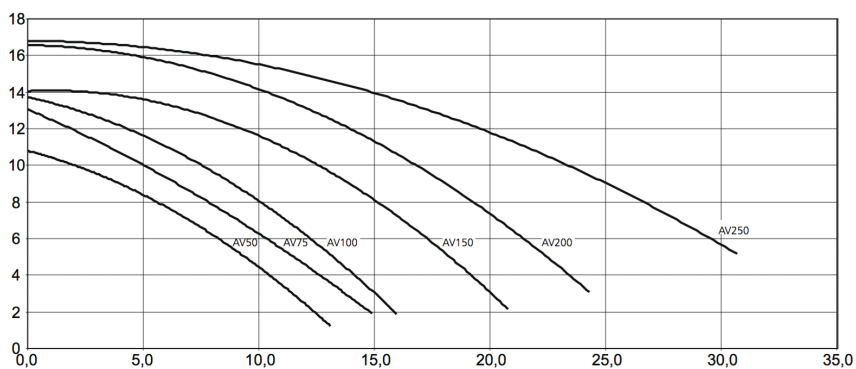
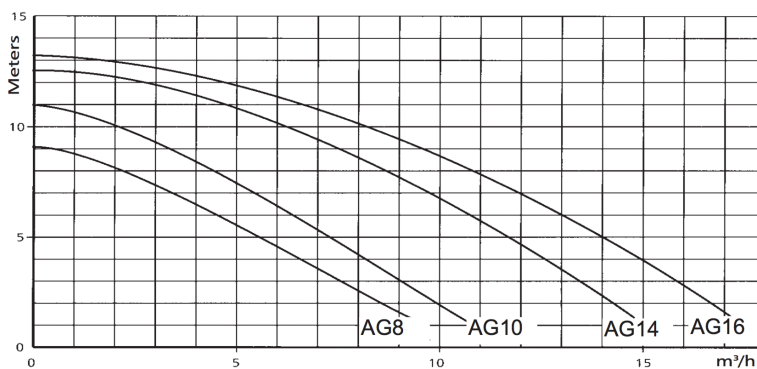
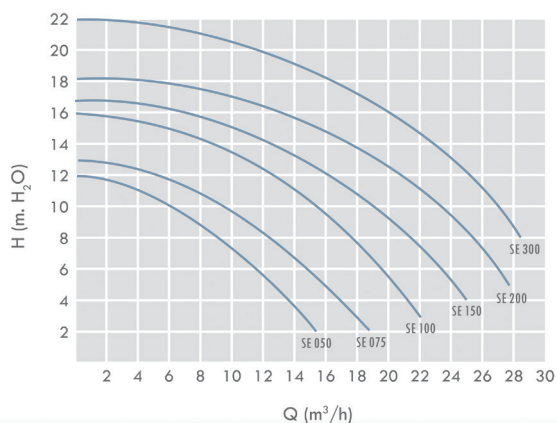
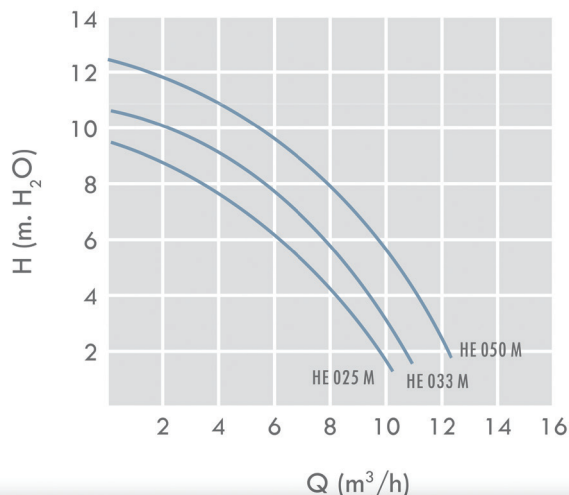
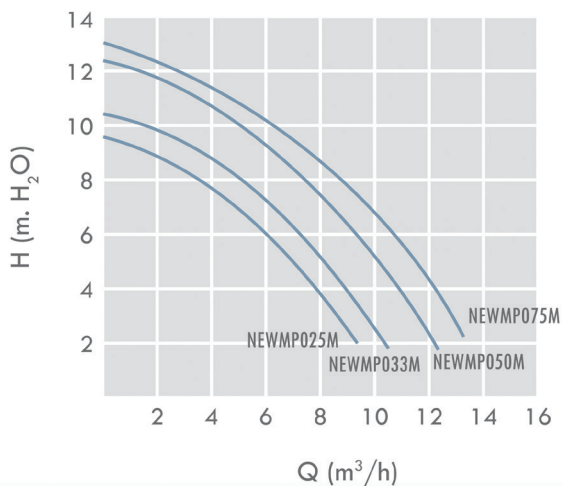

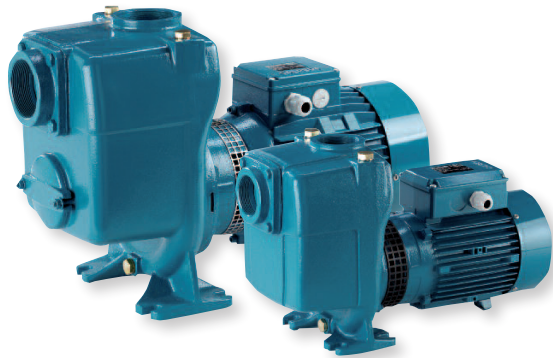

### Pompe centrifughe autoadescanti con girante aperto

Corpo ghisa o bronzo. Albero acciaio inossidabile. Dimensione granul. 10-15 mm.

### Self-priming centrifugal pumps with open impeller

Cast iron or bronze body. Stainless steel shaft. Grain size 10-15 mm.

### Öntöttvas vagy bronztest. Rozsdamentes acél tengely. Szemméret 10-15 mm.

Öntöttvas vagy bronztest. Rozsdamentes acél tengely. Szemméret 10-15 mm.

DESCR. / JEL.
U008390 Serie A / A-series / A-sorozat



### Pompe centrifughe orizzontali ad accoppiamento ravvicinato

Corpo e girante in ghisa o bronzo (B-##). Albero in acciaio inox. Motore a 2 tempi / 2900 rpm (NM) o 4 tempi / 1450 rpm (NM4). Rivestimento in ceramica opzionale. Disponibile anche in acciaio inossidabile (corpo e girante) e/o con accoppiamento (Serie SHE/FHS/SHS/FHF/SHF).

### Horizontal close-coupled centrifugal pumps

Cast iron or bronze (B-##) body and impeller. Stainless steel shaft. Motor 2-pole / 2900 rpm (NM) or 4-pole / 1450 rpm (NM4). Ceramic coating in option. Also available in stainless steel (body and impeller) and/or with coupling (SHE/FHS/SHS/FHF/SHF-series).

### Vízszintes szorosan kapcsolt centrifugálszivattyúk

Öntöttvas vagy bronz (B-##) test és járókerék. Rozsdamentes acél tengely. Motor 2 pólusú/2900 fordulat/perc (NM) vagy 4 pólusú / 1450/perc (NM4). Kerámia bevonat választható. Rozsdamentes acélból (test és járókerék) és/vagy csatlakozóval (SHE / FHS / SHS / FHF / SHF sorozat) is kapható.

DESCR. / JEL.
U009300 Serie NM & B-NM / NM & B-NM series / NM & B-NM sorozat
U008400 Serie NM4 & B-NM4 / NM4 & B-NM4 series / NM4 & B-NM4 sorozat

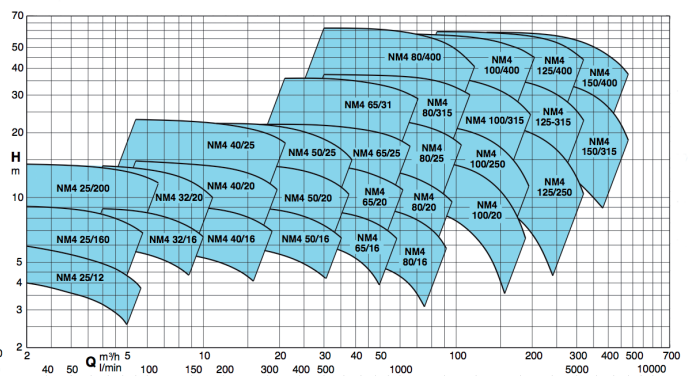
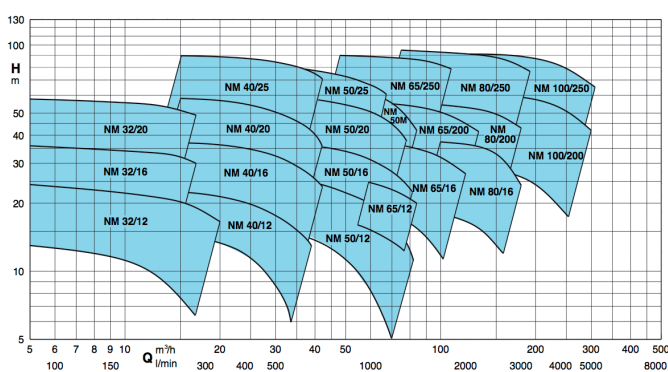
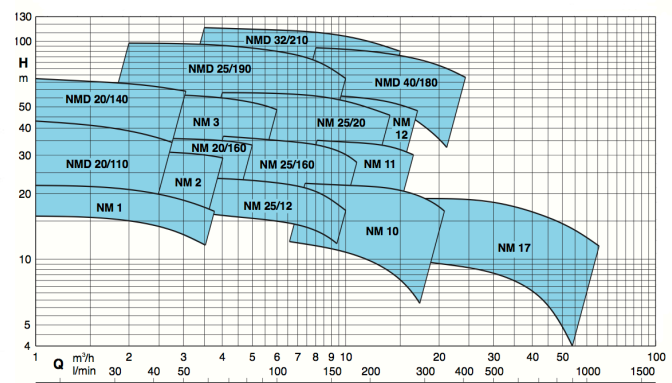
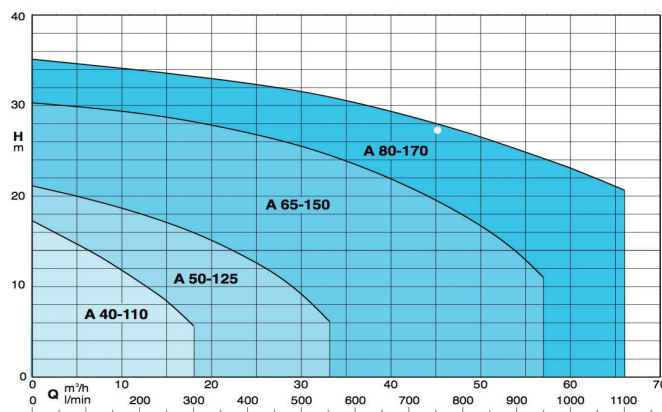

### Pompe centrifughe in materiali speciali

Corpo della pompa in vinile rinforzato in fibra di vetro o resina epossidica (processo RTM: Resin Transfer Molding).

### Special material centrifugal pumps

Pump body made of fiberglass reinforced vinylester or epoxy resin (RTM process: Resin Transfer Molding).

### Speciális anyagú centrifugászivattyúk

Üvegszálal erősítésű vinil-észterből vagy epoxi-gyantából készült szivattyútest (RTM eljárás: Resin Transfer Molding).

DESCR. / JEL.
U009910 Serie Fybroc 1500 / Fybroc 1500-series / Fybroc 1500 sorozat

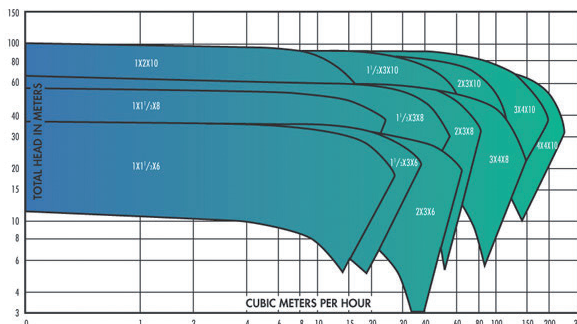
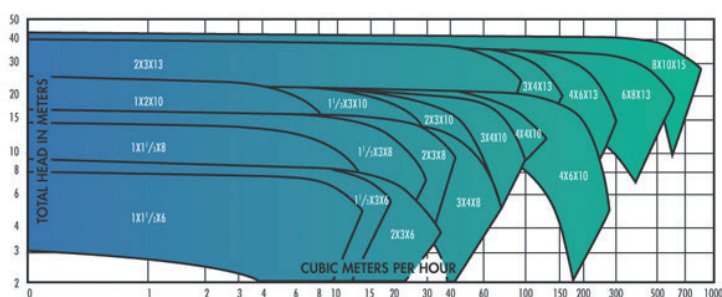
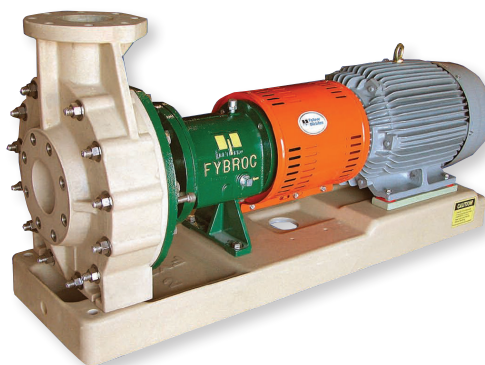

### Pompe a bassa tensione

Adatte per l'acqua di mare. Uso sommerso o asciutto. Solidi fino a 6 mm. Alimentazione 12 V DC (opzione 230 V/50 Hz-1). Su richiesta : bronzo 12-24 VDC.

### Low voltage pumps

Suitable for seawater. Submerged or dry use. Solids up to 6 mm. Power supply 12 V DC (option 230 V/50 Hz~1). On request : bronze 12-24 VDC.

### Kisfeszültségű szivattyúk

Tengeri vízhez alkalmas. Merülő vagy száraz felhasználás. Szilárd anyag 6 mm-ig. Tápegység 12 V DC (opció: 230 V / 50 Hz ~ 1). Megrendelésre: bronz 12-24 VDC.

DESCR. / JEL.	W (W)	→↑↑ (mm)	⊕ (mm)
U005010 DM-3500 LV	30	190 × 105 × 130	1 1/4"
U005020 DM-5000 LV	40		
U005030 DM-6500 LV	50		
U005040 DM-8000 LV	70		
U005050 DM-10000 LV	85		
U005060 DM-12000 LV	90	215 × 126 × 155	2"
U005070 DM-15000 LV	190		

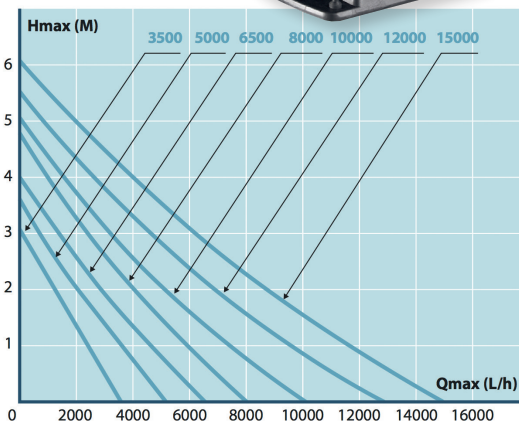

### Pompe verticali multicellulari

Realizzato in acciaio inox AISI304 o AISI316. Manutenzione facile. Applicazione tipica : aumento della pressione. Compatibile con sistema di controllo della frequenza Hydrovar.

### Vertical multicellular pumps

Made of stainless steel AISI304 or AISI316. Easy maintenance. Typical application : pressure boosting. Hydrovar frequency control system compatible.

### Függőleges többrekeszes szivattyúk

Rozsdamentes acélból készült AISI304 vagy AISI316. Könnyű karbantartás. Tipikus alkalmazás: nyomásnövelés. Hidrovari frekvenciaszabályozó rendszerrel kompatibilis.

DESCR. / JEL.
U006000 Serie e-SV / e-SV series / e-SV sorozat

Disponibile anche: versione orizzontale, motore a 4 tempi, materiale in titanio, etc...

Also available : horizontal version, 4-pole motor, titanium material, etc...

szintén kapható: vízszintes változat, 4 pólusú motor, titán anyag stb.



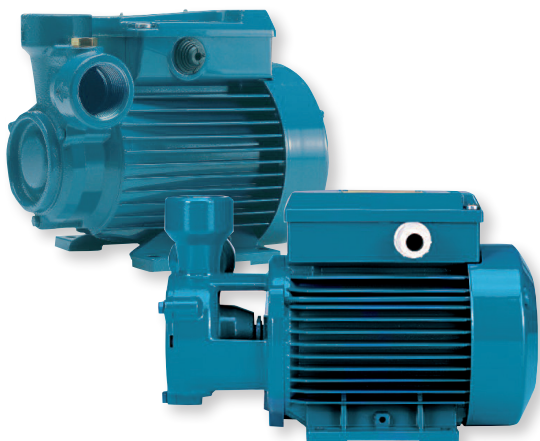
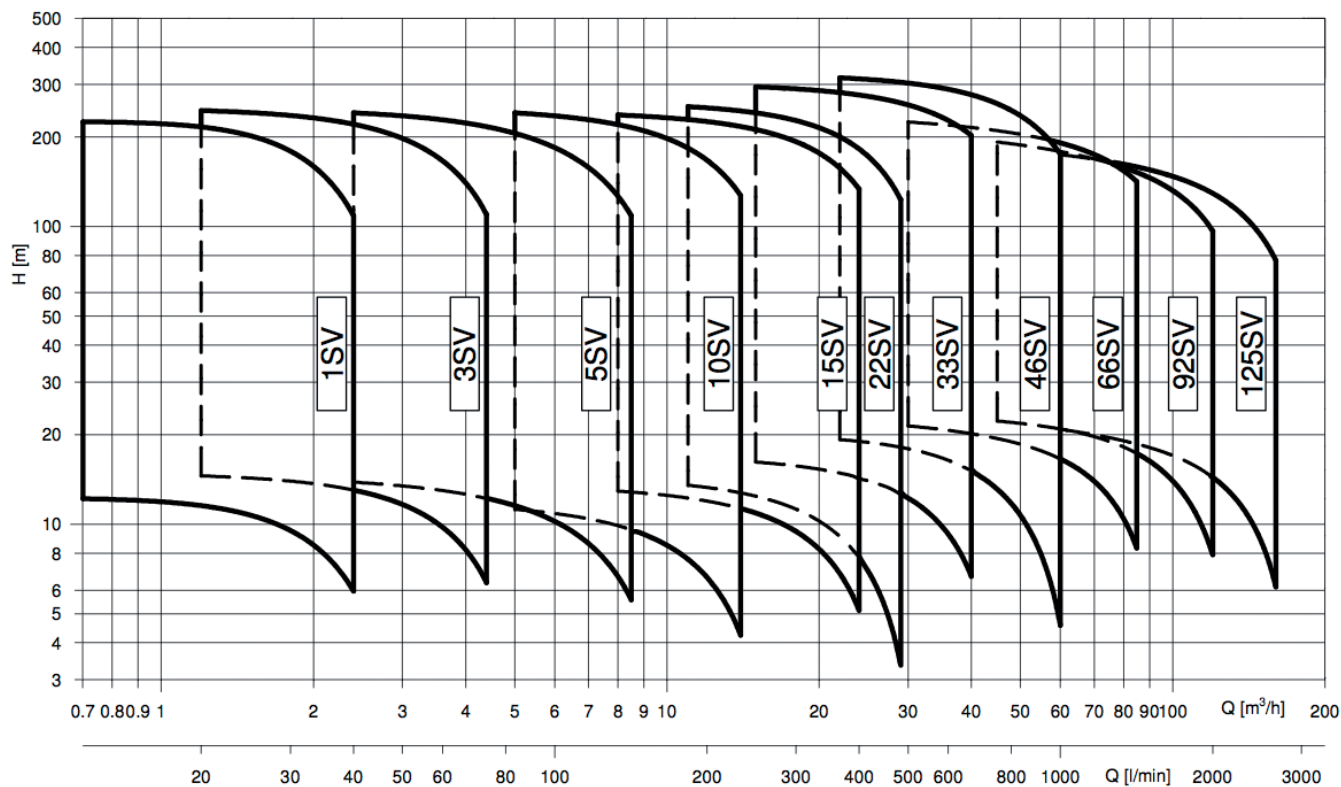

**Pompe periferiche**

Corpo in ghisa o bronzo. Girante in ottone o bronzo. Albero in acciaio inox (AISI 303/430/316). Applicazione : aumento della pressione della rete.

**Peripheral pumps**

Cast iron or bronze body. Brass or bronze impeller. Stainless steel (AISI 303/430/316) shaft. Application : increasing network pressure.

**Perifériás szivattyúk**

Öntöttvas vagy bronztest. Sárgaréz vagy bronz járókerék. Rozsdamentes acél (AISI 303/430/316) tengely. Alkalmazás: hálózati nyomás növelése.

	DESCR. / JEL.
U007000	Serie T, TP & B-T, B-TP / T, TP & B-T, B-TP series / T, TP & B-T, B-TP sorozat

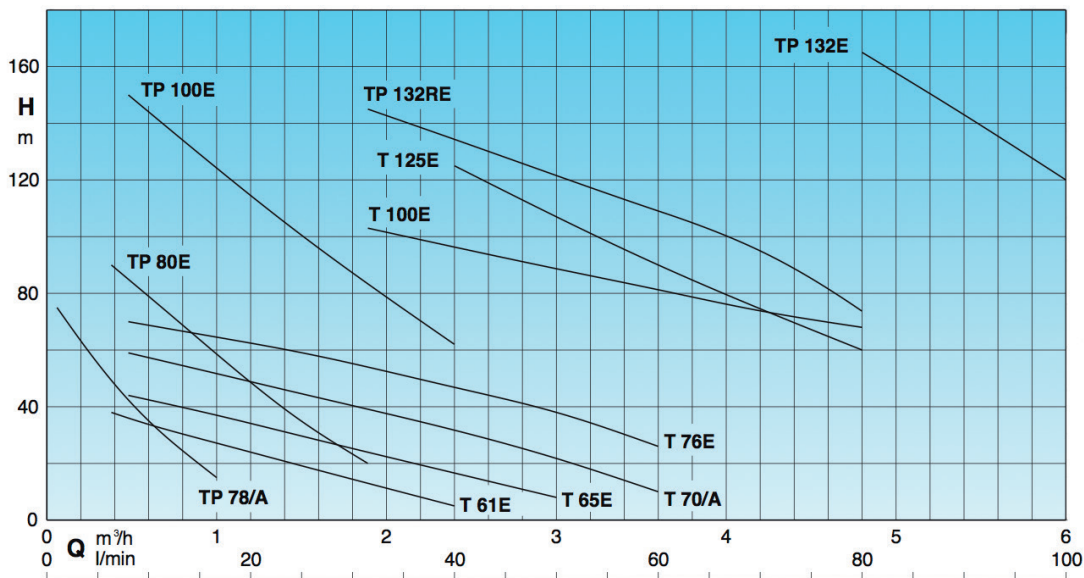

### Circolatori

Versione a 3 velocità con motore a induzione a 2 o 4 tempi, o versione a velocità variabile guidata da magnete sincrono permanente. Corpo in ghisa o bronzo, girante composita, albero in ceramica o acciaio inossidabile.

### Circulators

3-speeds version with 2- or 4- pole induction motor, or variable speed version driven by permanent magnet synchronous magnet. Cast iron or bronze body, composite impeller, ceramic or stainless steel shaft.

### Keringetőszivattyúk

Háromsebességű változat 2 vagy 4 pólusú indukciós motorral, vagy változó fordulatszámú változat állandó mágneses szinkron mágnes által hajtott. Öntöttvas vagy bronztest, kompozit járókerék, kerámia vagy rozsdamentes acél tengely.

DESCR. / JEL.	
U008000	Serie NC, NCE, NC3 / NC, NCE, NC3 series / NC, NCE, NC3 sorozat

Anche disponibile: pompe in linea ad alto flusso / Also available: high-flow in-line pumps  
Szintén kapható: nagy áramlású soros szivattyúk

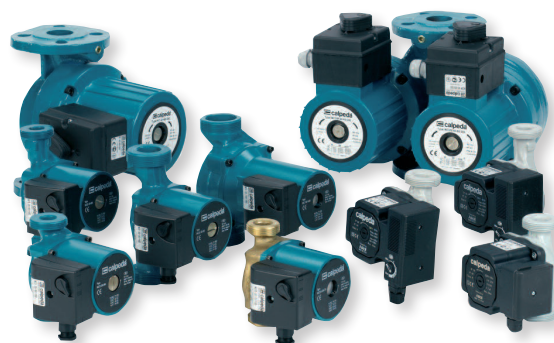

### Pompe di drenaggio sommergibili

Corpo e girante polimero (GM) o acciaio inoss. AISI 304 (GX) o ghisa (GQ). Albero in acciaio inox (AISI 430/303/304). Girante aperto (-R) o girante a vortice (-V). Filtro da 8-10 mm. Cavo da 5m (GM, GX) o 10 m (GQ). Interruttore galleggiante (~1).

### Submersible drainage pumps

Body and impeller made of polymer (GM) or stainless steel AISI 304 (GX) or cast iron (GQ). Stainless steel shaft (AISI 430/303/304). Open impeller (-R) or vortex impeller (-V). Strainer 8-10 mm. Cable 5 m(GM, GX) or 10 m (GQ). Float switch (~1).

### Merülő víztelenítő szivattyúk

Test és járókerék polimerből (GM) vagy rozsdamentes acélból AISI 304 (GX) vagy öntöttvasból (GQ). Rozsdamentes acél tengely (AISI 430/303/304). Nyitott járókerék (-R) vagy örvény-járókerék (-V). Szűrő 8-10 mm. Kábel 5 m (GM, GX) vagy 10 m (GQ). Úszó kapcsoló (~1).



Girante aperto / Open impeller / Nyitott járókerék							
DESCR. / JEL.	DESCR. / JEL.	DESCR. / JEL.	∕ (kW)	∅ × ↑ (mm)	Υ (kg)	⊕ (")	
230 V~1	400 V~3	DESCR. / JEL.					
U004806	U004807	GX ZERO	0,25	176 × 265	5,2	1 1/4	
U004811	U004812	GXR 9					
U004831	U004832	GXR 11	0,37	176 × 300	6,5		
U004851	U004852	GXR 13	0,45		7,2		
U004901	U004902	GQR 10-10	0,45	190 × 390	15	1 1/2	
U005001	U005002	GQR 10-12	0,55		15		
U005101	U005102	GQR 10-14	0,75	190 × 405	15		
U005201	U005202	GQR 10-16	0,9		17		
U005301	U005302	GQR 10-18	1,1	190 × 450	18		
U005401	U005402	GQR 10-20	1,5		19		
Girante a vortice / Vortex impeller / Örvény-járókerék							
DESCR. / JEL.	DESCR. / JEL.	DESCR. / JEL.	∕ (kW)	∅ × ↑ (mm)	Υ (kg)		⊕ (")
230 V~1	400 V~3	DESCR. / JEL.					
U004801	-	GM 10	0,30	179 × 212	5	1 1/2	
U004821	U004822	GXV 25-6	0,25	176 × 302	5,3	1 1/4	
U004841	U004842	GXV 25-8	0,37				
U004861	U004862	GXV 25-10	0,45	176 × 337	7,3		
U005011	U005012	GQV 50-8	0,55	183 × 445	16		
U005111	U005112	GQV 50-9	0,75		17		
U005211	U005212	GQV 50-11	0,9	183 × 485	19	1 1/2	
U005311	U005312	GQV 50-13	1,1		20		
U005402	U005412	GQV 50-15	1,5	183 × 505	21		

Disponibile anche: ~1 senza galleggiante o ~3 con galleggiante, GQS (id. GQV con presa verticale), modelli in acciaio inox GXC 40 e GXV 40, gamma GXR12 (vedi curva).

Also available: ~1 without float or ~3 with float, GQS (id. GQV with vertical outlet), st. steel versions GXC 40 & GXV 40, GXR12 range (see curves).

szintén kapható: ~1 úszó nélkül vagy ~3 úszó nélkül, GQS (GQV azonosító függőleges kimenettel), rozsdamentes acél kivitel GXC 40 és GXV 40, GXR12 tartomány (lásd a görbét).





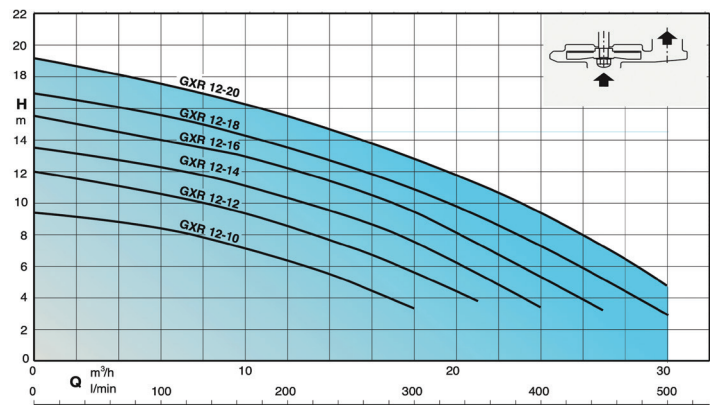
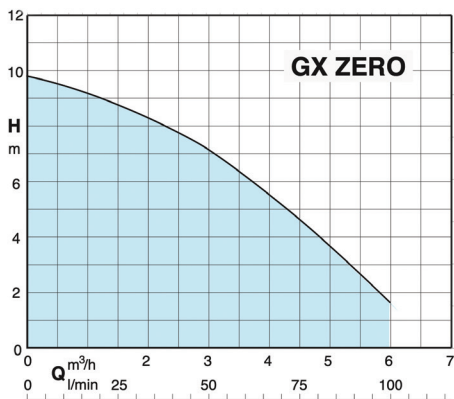
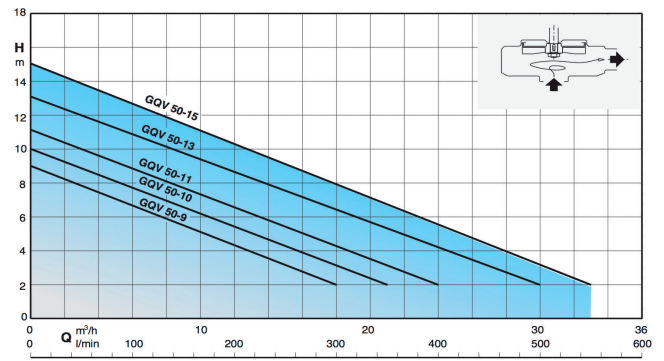
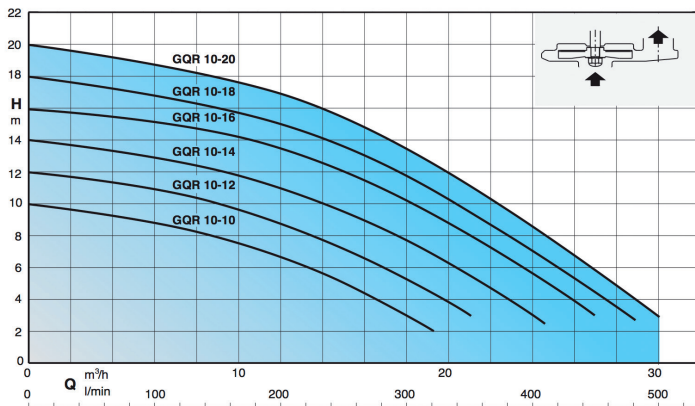
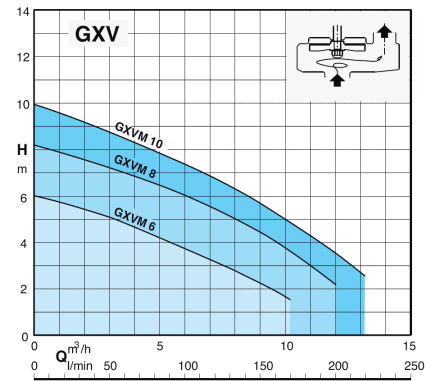
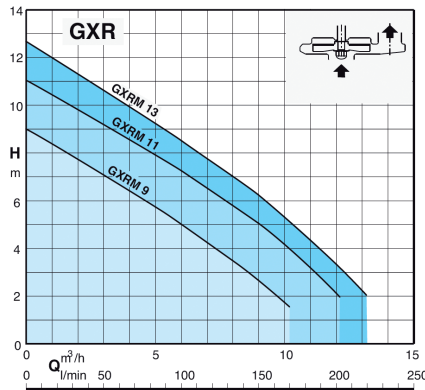
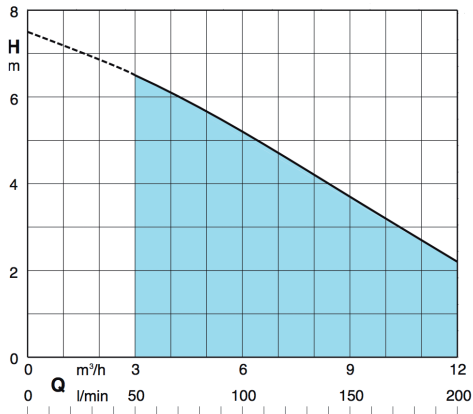

### Pompe fognarie sommerse

Girante aperta multicanale (DR) o vortice set-back (DG) o girante chiuso a canale singolo/doppio (SM/SB) o smerigliatrice (GR). Materiale in ghisa (-N) o acciaio inossidabile (-X, -Y) o bronzo (-B). Motore 2-, 4 o 6-tempi). Accessori su richiesta.

### Submersible sewage pumps

Multi-channel open-impeller (DR) or set-back vortex (DG) or single/dual channel closed impeller (SM/SB) or grinder (GR). Cast-iron material (-N) or stainless steel (-X, -Y) or bronze (-B). Motor 2-, 4- or 6-pole). Accessories on request.

### Merülő szennyvízszivattyúk

Többcsatornás nyitott járókerék (DR) vagy visszamenő csavaros (DG) vagy egy-/kétcsatornás zárt járókerék (SM / SB) vagy daráló (GR). Öntöttvas anyag (-N) vagy rozsdamentes acél (-X, -Y) vagy bronz (-B). Motor 2, 4 vagy 6 pólusú). Kiegészítők megrendelésre.

📖	DESCR. / JEL.
U005810	Serie DR / DR-series / DR sorozat [DRN, DRP, DRX, DRY, DRB]
U005820	Serie DG / DG-series / DG sorozat [DGN, DGP, DGX, DGB]
U005830	Serie SM & SB / SM- & SB-series / SM & SB sorozat [SMN, SMP, SBN, SBP]
U005840	Serie GR / GR-series / GR sorozat [GRN, GRP]

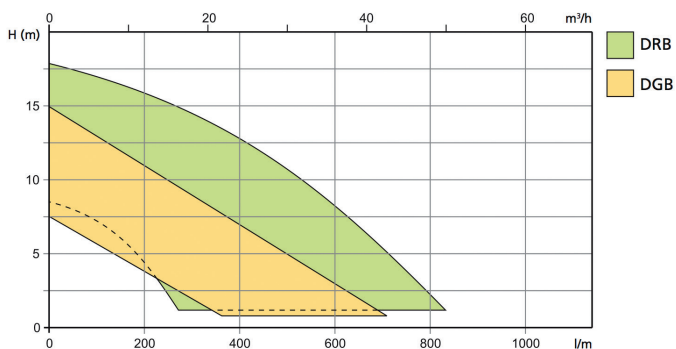
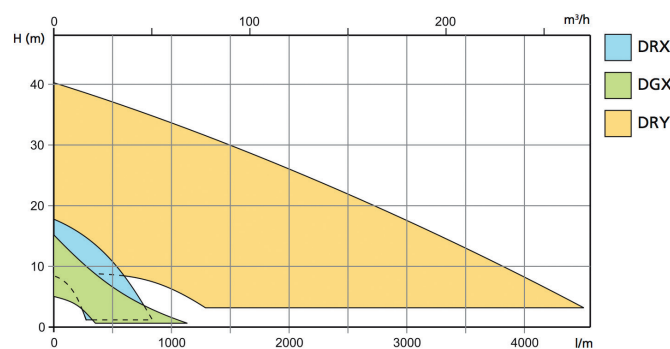
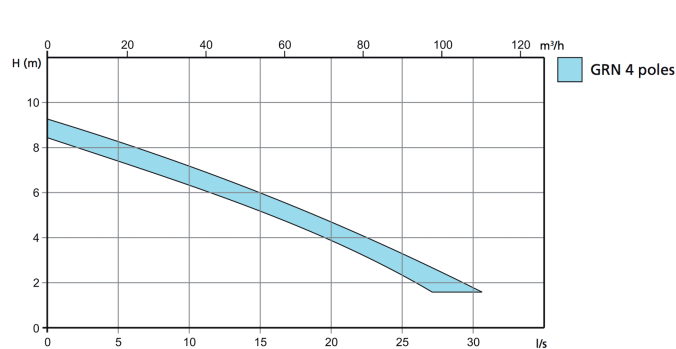
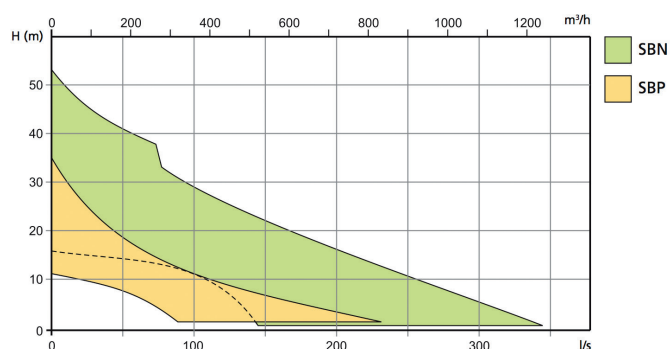
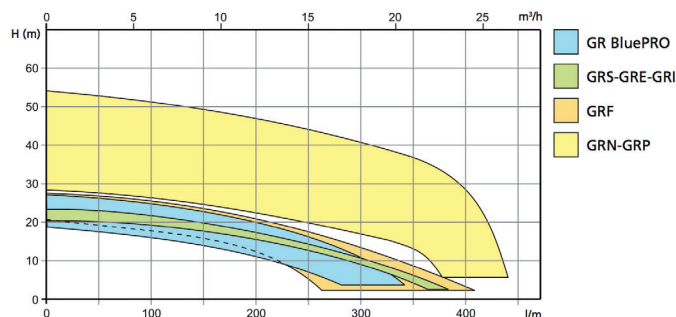
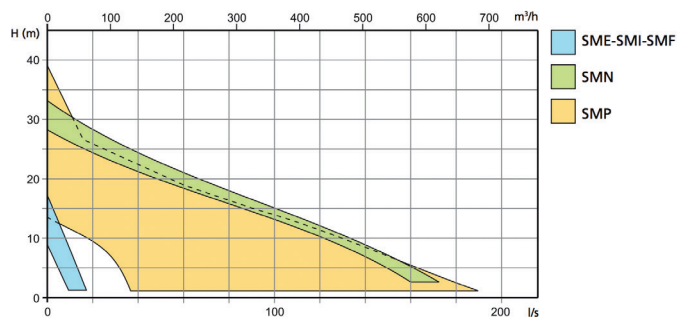
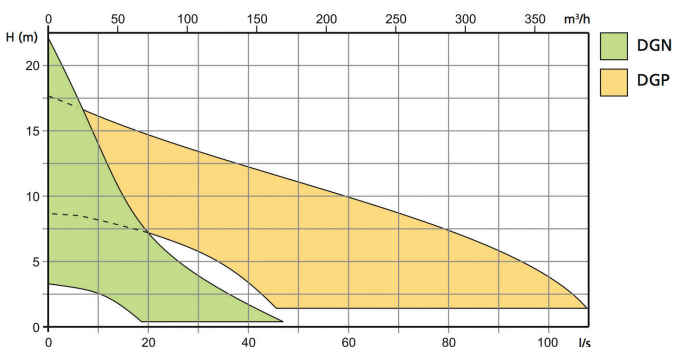
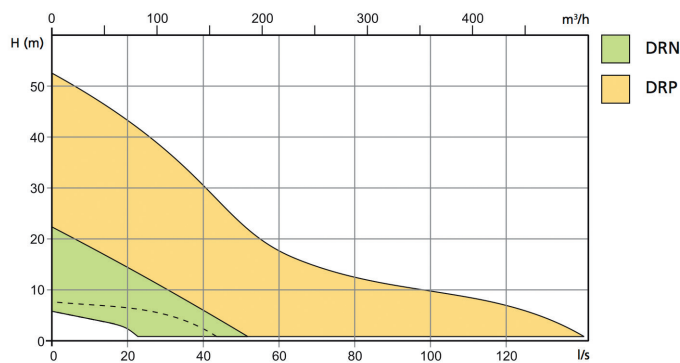

**Pompe sommerse verticali**

Corpo sommerso e motore in aria. Corpo in ghisa o vinile rinforzato con fibra di vetro o resina epossidica. Girante in ottone o resina.

**Vertical submerged pumps**

Submerged body and motor in air. Body made of cast iron or fiberglass reinforced vinylester or epoxy resin. Brass or resin impeller.

**Függőleges merülő szivattyúk**

Merülő test és motor a levegőben. Öntöttvasból vagy üvegszállal erősített vinil-észterből vagy epoxi-gyantából készült test. Sárgaréz vagy gyanta járókerék..

	DESCR. / JEL.
U008310	Serie VAL / VAL-series / VAL sorozat





### Pompe boro

Pompe monoblocco a più stadi, acciaio inossidabile AISI304, Ø 130 mm (MXS) e pompe con giranti a flusso radiale o radiale-galleggiante o misti, Ø 4", 6", 8 o 10", corpo in acciaio inossidabile AISI 304 e giranti/diffusori in policarbonato o Noryl (SD) o acciaio inossidabile AISI 304 (SDX) o AISI 316 (SDXL) o completamente in ghisa o bronzo (SDS). Maniche di raffreddamento in PVC o acciaio inossidabile, per una o due pompe, per l'installazione orizzontale. Accessori su richiesta.

### Borehole pumps

Close-coupled multi-stage pumps, stainless steel AISI304, Ø 130 mm (MXS) and pumps with radial or radial-floating or mixed flow impellers, Ø 4", 6", 8" or 10", stainless steel body AISI 304 and polycarbonate or Noryl impellers/diffusers (SD) or full stainless steel AISI 304 (SDX) or AISI 316 (SDXL) or full cast iron or bronze (SDS). Cooling sleeves made of PVC or stainless steel, for one or two pump(s), for horizontal installation. Accessories on request.

### Furatszivattyúk

Zárolt tengelykapcsolt többlépcsős szivattyúk, rozsdamentes acél AISI304, Ø 130 mm (MXS) és sugárirányú vagy sugárirányban úszó vagy vegyes áramlású járókerékkel ellátott szivattyúk, Ø 4", 6", 8" vagy 10", rozsdamentes acél test AISI 304 és polikarbonát vagy Noryl járókerék / diffúzor (SD) vagy teljes rozsdamentes acél AISI 304 (SDX) vagy AISI 316 (SDXL) vagy teljes öntöttvas vagy bronz (SDS). Hűtő hüvelyek PVC-ből vagy rozsdamentes acélből, egy vagy két szivattyúhoz, vízszintes beépítéshez. Kiegészítők megrendelésre.

Icon	DESCR. / JEL.
U010000	Série MXS / MXS-series / Serie MXS
U010320	Séries SD / SD-series / Serie SD

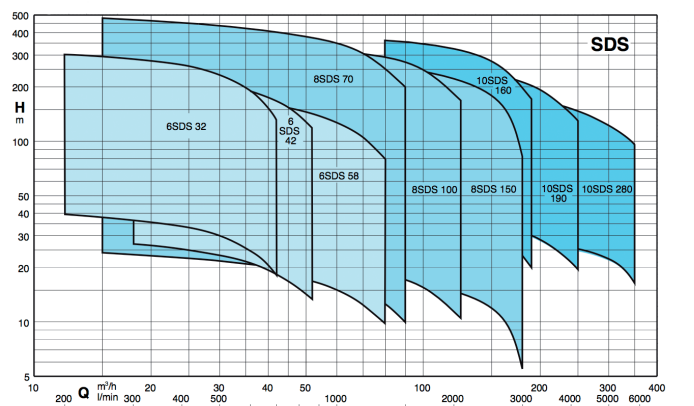
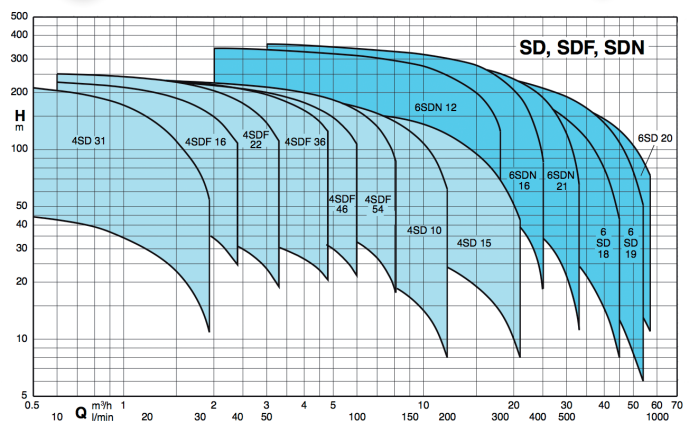
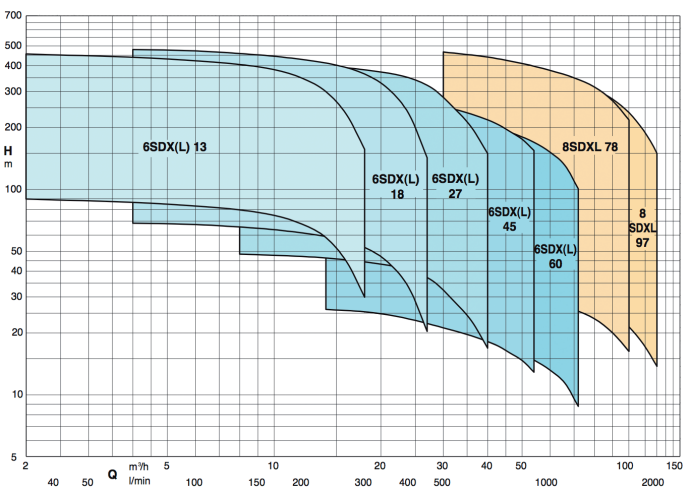
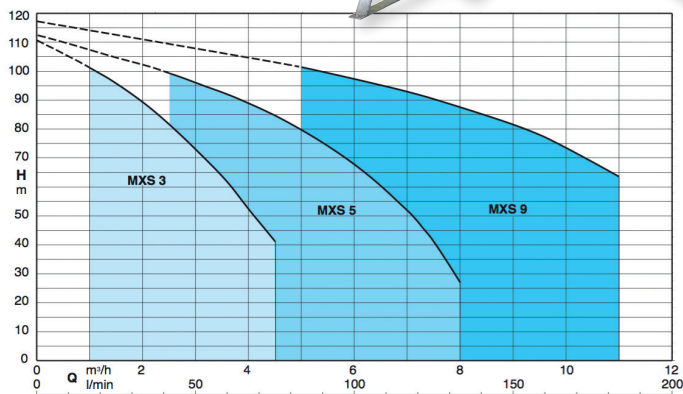

### Pompe a elica

Pompe basso consumo / alto flusso. Serie L e S completamente realizzata in acciaio inossidabile AISI 304. Serie H con corpo in ghisa e girante in alluminio/ bronzo. Serie a V con corpo in acciaio zincato o acciaio inoss. e girante in acciaio inoss. o plastica. Serie UPL con corpo in ghisa o bronzo e girante in bronzo.

### Propeller pumps

Low head / high flow pumps. L- and S-series fully made of stainless steel AISI 304. H-series with cast iron body and aluminium/bronze impeller. V-series with galvanized or stainless steel body and stainless steel or plastic impeller. UPL-series with cast iron or bronze body and bronze impeller.

### Propelleres szivattyúk

Alacsony fejű/magas áramlású szivattyúk. L- és S-sorozat teljesen rozsdamentes acélból készült AISI 304. H-sorozat öntöttvas testtel és alumínium/bronz járóke- rékkel. V-sorozat galv. vagy rozsd. acél testtel és rozsd. acél vagy műanyag járóke- rékkel. UPL sorozat öntöttvas vagy bronz testtel és bronz járókerékkel.

230 V~1	400 V~3	DESCR. / JEL.	(kW)	Ø × ↑ (mm)	Y (kg)	⊕ (")
Serie L / L-series / L sorozat						
U010401	-	L01	0,1	275 × 420	12	DN70
U010501	-	L02	0,18		15	DN100
-	U010552	L02B	0,25	350 × 520	25	DN125
U010601	U010602	L03	0,40			
U010701	U010702	L04	0,55			
U010800	U010801	L05	0,75			
U010900	U010901	L06	0,75			
-	U011001	L07	1,1			
-	U011101	L08	1,1			
-	U011111	L10	1,1			
Serie S / S-series / S sorozat						
U011150	U011151	S01	0,15	290 × 530	12	DN100
-	U011161	S02	0,25			DN125
-	U011171	S03	0,75			15
-	U011181	S04	1,1	340 × 620		
-	U011182	S05	1,5	350 × 750	40	
Serie H / H-series / H sorozat						
U011185	U011186	H-305	0,4	230 × 484	26	DN80
U011187	U011188	H-41	0,75			DN90/100
-	U011190	H-62	1,5	285 × 597	51	DN150
-	U011192	H-63	2,2			
-	U011194	H-200A	5,5	340 × 923	116	DN200
-	U011196	H-250A	7,5	380 × 1015	157	DN250
-	U011198	H-300A	11	430 × 1077	201	DN300
Serie V / V-series / V sorozat						
-	U011410	V160	3 ... 5,5	160	-	DN150
-	U011420	V200	4 ... 9	200		DN200
-	U011430	V260	5,5 ... 15	260		DN250
-	U011440	V350	15 ... 30	350		DN300
Serie ORP / ORP-series / ORP sorozat						
U011460	-	ORP 25000	0,188	200 × 400	6	DN100
U011465		ORP 30000	0,235			
U011470		ORP 40000	0,299			
U011475		ORP 50000	0,398			
U011480		ORP 60000	0,560			
U011485		BH 70000	0,540			

Serie V disponibili anche con diametri da 400 a 700mm  
V-series also available with diameter 400 up to 700 mm  
V-sorozat 400-700 mm átmérővel is kapható

Disponibile anche: Serie H pressione superiore (IC) circolatori per acquario Tunze Turbelle® con regolazione di flusso (1-80 m³/h), pompe UPL in linea (100-800 m³/h @ 0-16 m H₂O), ...  
Also available: H-series higher pressure (IC), aquarium circulators Tunze Turbelle® with flow regulation (1-80 m³/h), UPL inline pumps (100-800 m³/h @ 0-16 m H₂O), ...  
szintén kapható: H sorozatú magasabb nyomású (IC), Turbelle® akváriumí keringető szivat-  
tyúk áramlásszabályozóval (1-80 m³/h), UPL inline szivattyúk (100-800 m³/h @ 0-16 m H₂O)...

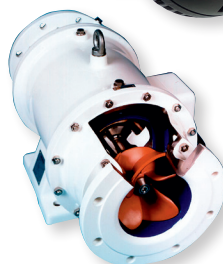
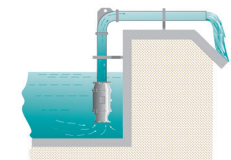
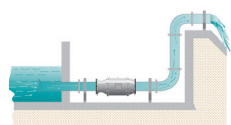
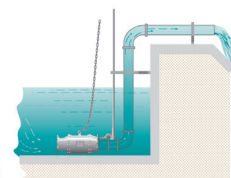
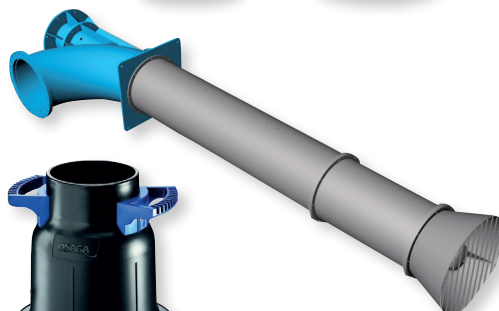

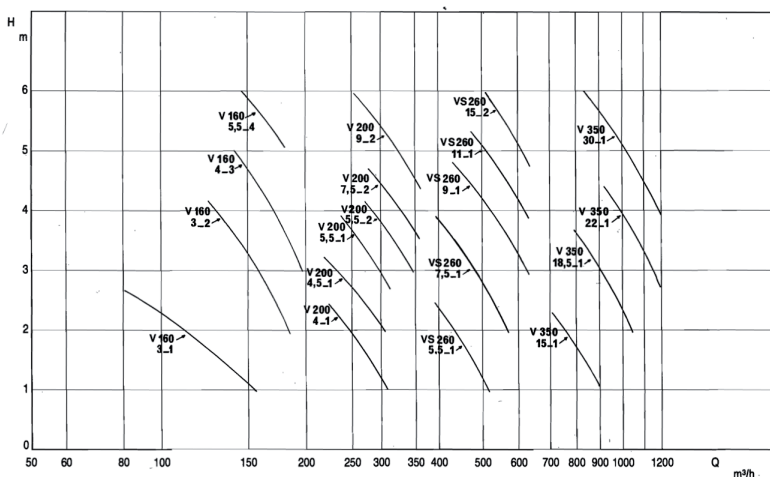
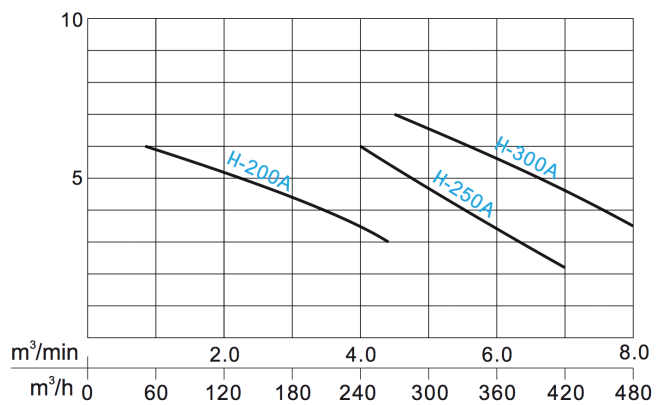
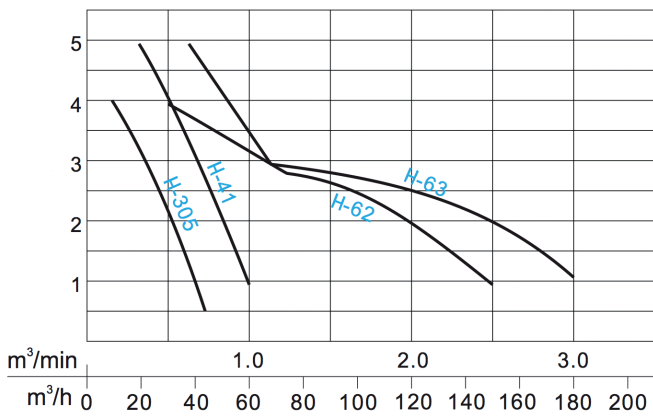
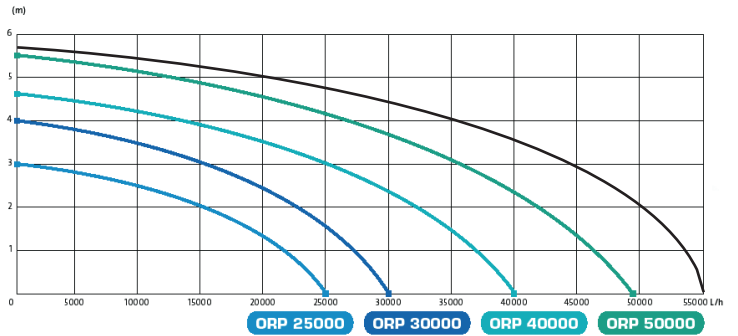
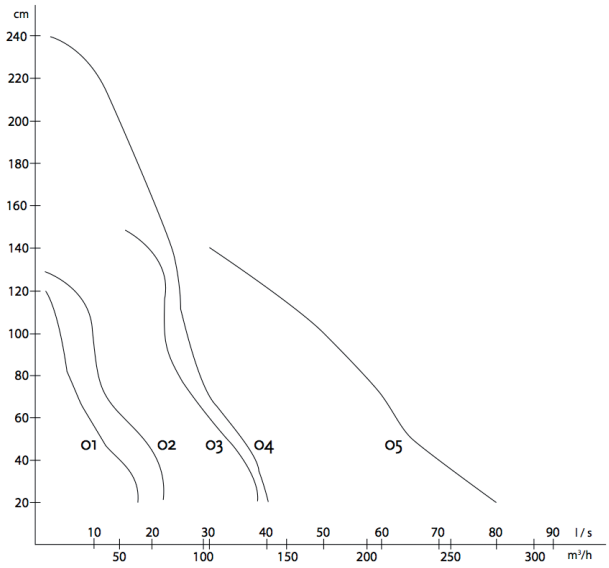
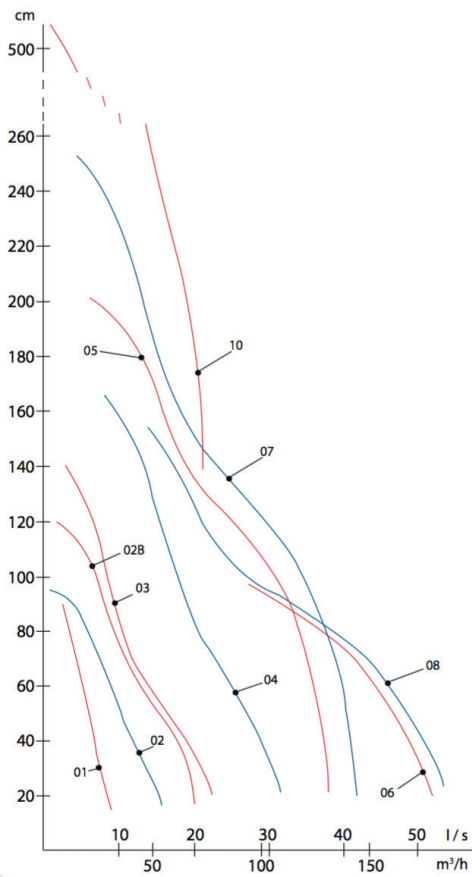

### Vite di Archimede

Pompe a vite adatte per il pompaggio ad alto flusso/basso consumo di liquidi fortemente inquinati. Utilizzato inclinato da 30° a 38°. Il rotore a vite (elica doppia o tripla) viene posato su una lastra di acciaio o in un canale di cemento (opzionale con rivestimento acciaio inox o ceramica). Mat. : acciaio dolce, inoss. e ghisa.

### Archimedes screw

Screw pumps suitable for high flow/low head pumping of strongly polluted liquids. Used for inclination 30° ... 38°. The screw rotor (double or triple helix) is laid into a steel plate or concrete channel (optionally with stainless steel or ceramic lining). Materials : mild steel, stainless steel and cast iron.

### Archimedes csavar

Az erősen szennyezett folyadékok nagy áramlású/alacsony fejtű szivattyúzásához megfelelő csavarshivattyúk. 30°-38° dőléshez használható. A csavarrotor (kettős vagy hármasspirál) acéllemezre vagy betoncsatornára van felszerelve (opcionálisan rozsd. acélból vagy kerámia béléssel). Anyagok: lágy, rozsd. acél és öntöttvas.

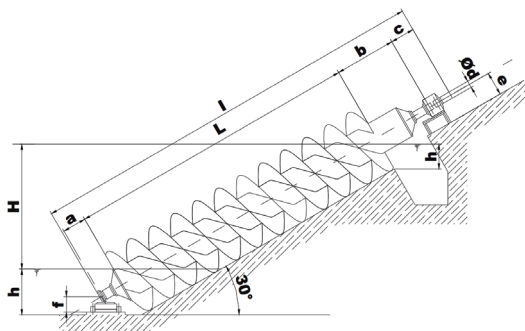

Ø (mm)	Q (L/s)	H <sub>max.</sub> (m)	↗ (kW)	
U010340	280	10	3,5	0,34
U010345	410	28	4,25	1,17
U010350	500	45	4,5	1,99
U010355	600	68	5	3,34
U010360	720	105	5,5	5,67
U010365	880	180	5,75	10,2
U010370	1050	275	6	16,2
U010375	1280	450	6,5	28,7
U010380	1550	700	7	48,1
U010385	1850	1100	7,5	80,9
U010390	2250	1700	7,5	125,1
U010395	3000	3000	75	220,7

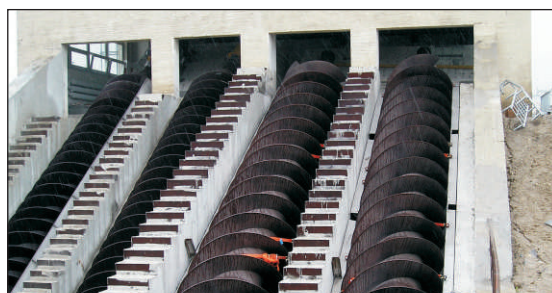

*dati forniti per un'inclinazione a 30° / data given for 30° inclination /  
a 30°-os dőlésre megadott adatok*

Disponibili anche su richiesta: gruppi pompa di aumento pressione, velocità variabile, quadri elettrici e di controllo...

Also available on request : booster pump sets, variable speed, control and electrical boxes...

Igény szerint is kapható: nyomásfokozó szivattyú készletek, változtatható fordulatszám, vezérlő és elektromos dobozok...



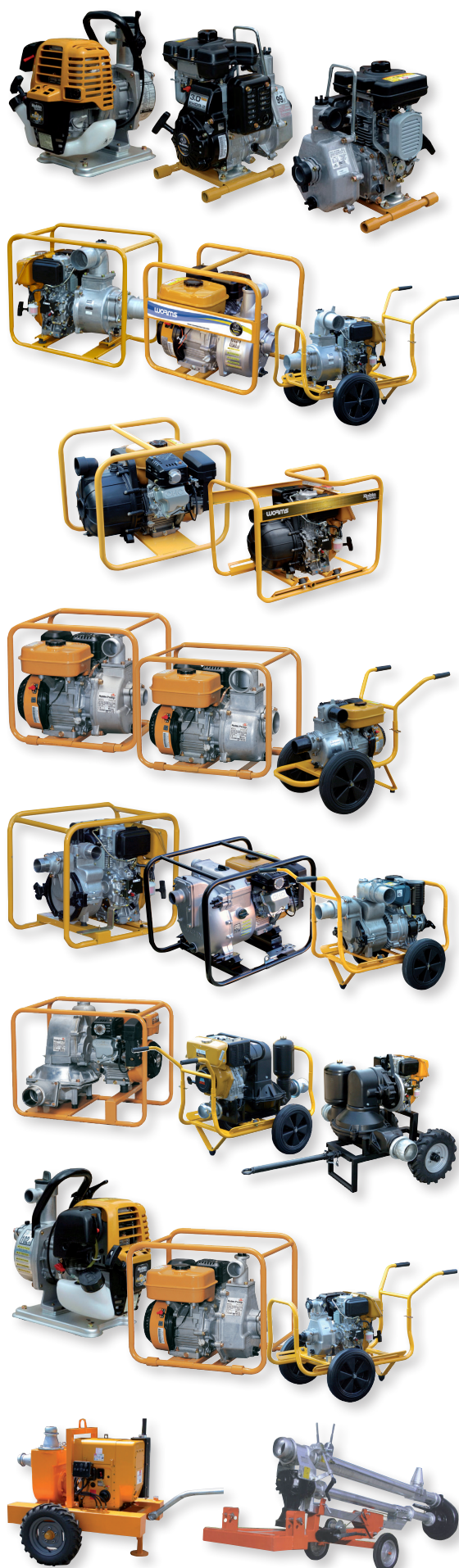

### Pompe a motore

Pompe autoadescanti. JARD acqua limpida ; Cestino TP/RD ; THERMO (P) super spazzatura, corpo termoplastico ; TH super spazzatura ; SWT per rifiuti super, lavori intensivi ; MECA membrana per rifiuti super ; JET alta pressione. Incluso filtro, raccordo e fascia per tubo. Opzioni : carrello, raccordi simmetrici, avvio elettrico, etc...

### Motor-driven pumps

Self-priming pumps. JARD clear water ; TP/RD trash ; THERMO (P) super trash, thermoplastic body ; TH super trash ; SWT super trash, intensive works ; MECA super trash, membrane ; JET high pressure. Including strainer, hose coupling and band. Options : trolley, symmetric couplings, electric starter, ...

### Motoros szivattyúk

Önindító szivattyúk. JARD tiszta víz; TP/RD szemét; THERMO (P) szuper szemétkosár, hőre lágyuló test; TH szuper szemétkosár; SWT szuper szemétkosár, intenzív munkák; MECA szuper szemétkosár, membrán; JET magas nyomású. Szűrővel, tömlőcsatlakozóval és szalaggal. Opciók: kocsi, szimmetrikus csatlakozók, elektromos indító, ...

📖	DESCR. / JEL.	🔋	Vol.	📏	➔➔➔	⚖️	⊕		
		[*]	(L)	(mm)	(mm)	(kg)			
<b>JARD</b>									
U011530	ACCESS J 8-25	G	1,5	5	385 × 300 × 375	14	1"		
U011535	ACCESS J 14-40				355 × 300 × 385		1 1/2"		
U011540	ACCESS J 36-50				477 × 395 × 410		23	2"	
U011545	ACCESS J 60-75			6	500 × 395 × 445	25	3"		
U011515	JARD 7 OHV				5,5	330 × 205 × 330	6,8	1"	
U011520	JARD 12 OHV					370 × 300 × 420	15,5		
U011525	JARD 20 OHV	16							
<b>TP/RD</b>									
U011555	RD 75 XL	D	13	7	680 × 410 × 590	51,5	4"		
U011610	TP 36 EX	G	2,7	5,5	500 × 395 × 440	24	2"		
U011615	TP 65 EX		3,6	7,5	540 × 400 × 480	25	3"		
U011620	TP 110 EX		5,5	7	618 × 485 × 570	30	4"		
<b>THERMO (P)</b>									
U011650	P 52 EX	G	3,6	-	520 × 400 × 425	24	2"		
<b>TH</b>									
U011710	TH 45 EX	G	2,7	20	470 × 344 × 414	25	2"		
U011715	TH 63 EX		3,6		510 × 387 × 448	31	3"		
<b>SWT</b>									
U011760	SWT 75 DXL	D	13	31	680 × 410 × 590	61	3"		
U011766	SWT 120 DXL				730 × 485 × 610	88,5	4"		
U011772	SWT 150 DXL				45	15	950 × 730 × 950	195	6"
U011775	SWT 50 EX	G	3,6	20	656 × 499 × 524	51	2"		
U011780	SWT 80 EX				6,1	27	721 × 516 × 585	63	3"
U011785	SWT 150 EXL 12				14	45	950 × 615 × 805	135	4"
<b>MECA</b>									
U011820	MECA 8/15 EX	G	2,7	25	660 × 420 × 510	43	2"		
U011825	MECA 16/20 EX		3,6			50	3"		
U011830	MECA 25		2,7			58,5	4"		
<b>JET</b>									
U011845	JET 100 DXL	D	13	-	670 × 640 × 650	88	2"		
U011860	JET 70 EX	G	3,6	5,5	539 × 368 × 455	28	2"		
U011875	JET 100 EX		6,1	-	640 × 480 × 590	42			

[\*] G = benzina / gasoline / benzin - D = diesel / diesel / dízel

Disponibili anche su richiesta: Pompe a motore ad alta potenza, rimorchio, pompe cardaniche ad elica motrice da trattor, ...

Also available on request : high power motopumps, trailer mounting, tractor cardan-driven propeller pumps, ...

Igény szerint szintén elérhető: nagy teljesítményű motorpumpák, pótkocsi felszerelése, traktor kardánhajtású légszűrő szivattyúi, ...

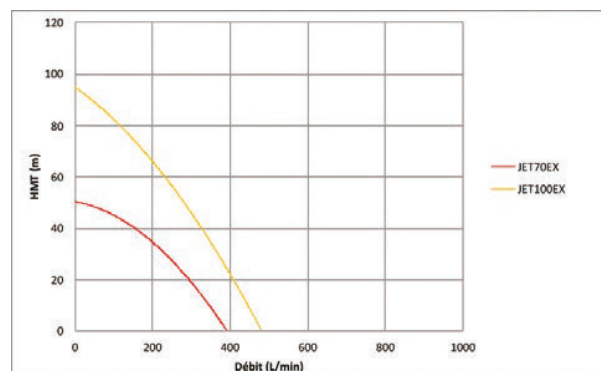
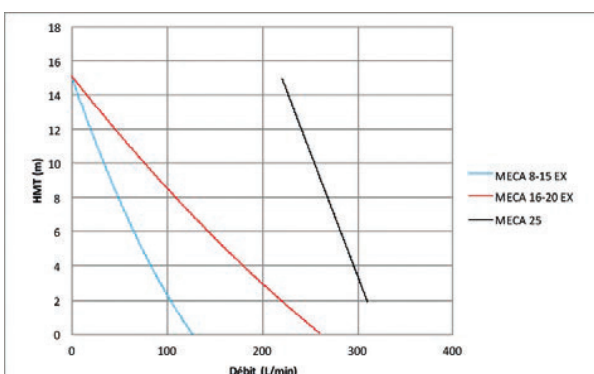
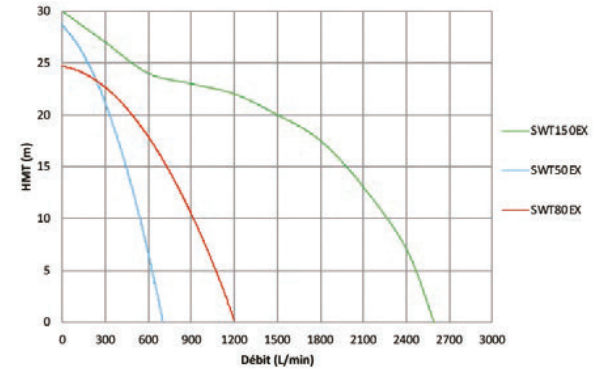
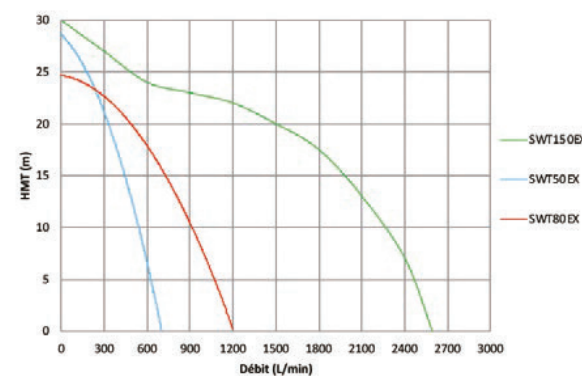
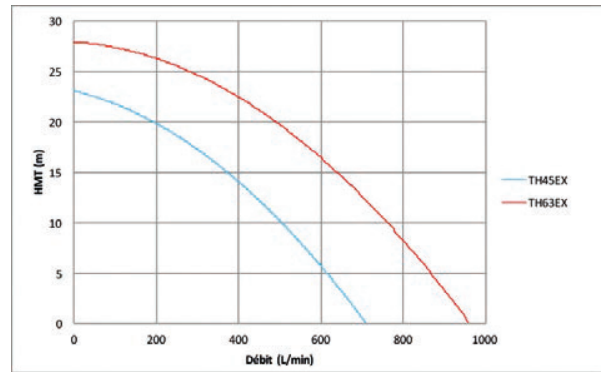
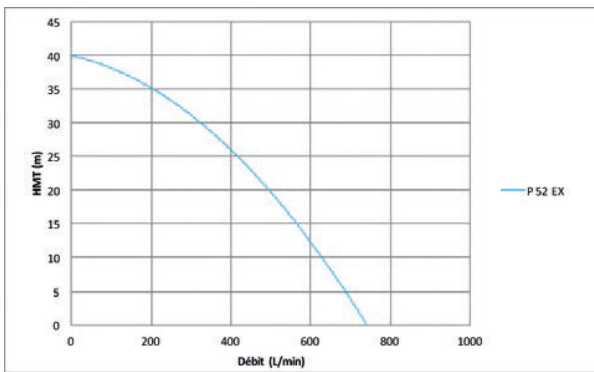
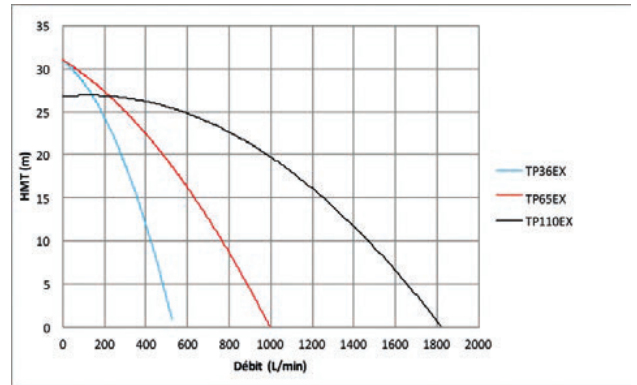
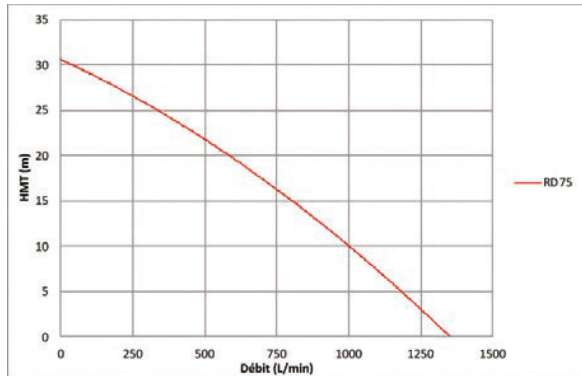
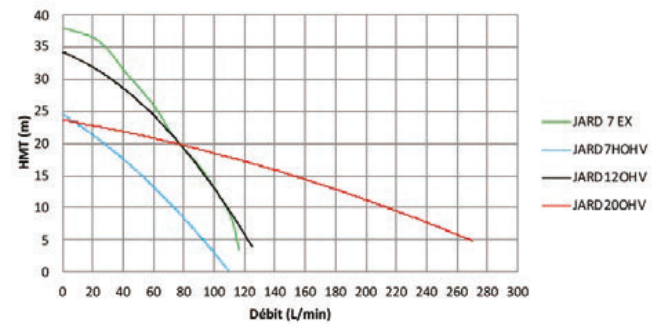
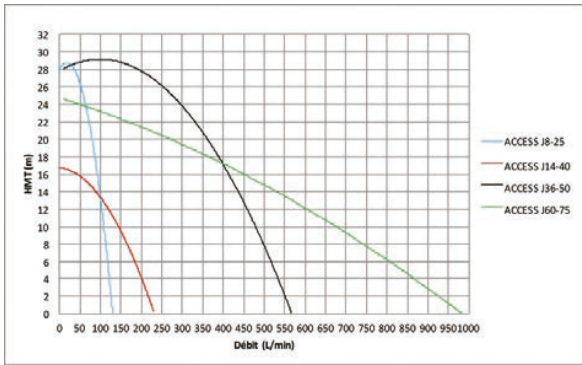





## Compressori

Compressori a pistone reciproco per officina, modello stazionario o senza olio silenziosi. A vite rotante con azionamento a cinghia, diretta o cambio. Disponibile: compressori portatili, trattamento dell'aria (essiccazione, filtrazione, stoccaggio).

## Compressors

Reciprocating piston compressors for workshop, stationary-design or silenced oil-free models. Rotary screw compressors with belt drive, direct or gearbox. Also available: portable compressors, air treatment (drying, filtration, storage, ...).

## Kompresszorok

Dugattyús kompresszorok műhelyhez, álló kialakítású vagy hangtompított olajmentes, közvetlen vagy sebességváltó. Forgócsavarkompresszor szíjhajtással. Kapható: hordozható kompresszorok, légtisztítás (szárítás, szűrés, tárolás, ...).

DESCR. / JEL.	Q (lpm)	P (bar)	~ (kW)
<b>Pistone / Piston / Dugattyú</b>			
U012900 A	190 ... 587	7 / 15	1,5 ... 3,8
<b>Vite / Screw / Csavar</b>			
U014000 COMBI	820 ... 2540	5 / 13	5,5 ... 22
U014600 BELT-XP	540 ... 4700		4 ... 37
<b>Scroll (senza olio / oil-free / olaj mentes)</b>			
U015020 Scroll	350 ... 1700	8 / 10	4 ... 15

soffiatori radiali pagine 43-44 / radial blowers pages 43-44 /  
radiális fúvók 43-44. oldalon

## Unità di generazione

IINVERTER a tensione stabilizzata, insonorizzata. EXP con motore OHC sopraelevato con albero a camme. LEADER con motore OHV sopraelevato a valvole. MASTER diesel. TRISTAR a tre fasi. SILENSTAR insonorizzato. Opzioni: interruttore 30 mA, avvio elettrico, avvio remoto, avvio automatico, spine, interruttore di trasferimento, carrello, grande serbatoio di carburante, ...

## Generating units

INVERTER stabilized voltage, soundproof. EXP with OHC overhead camshaft engine. LEADER with OHV overhead valves engine. MASTER diesel. TRISTAR three-phase. SILENSTAR soundproof. Options: circuit breaker 30 mA, electric start, remote start, automatic start, plugs, transfer switch, trolley, big fuel tank, ...

## Generáló egységek

INVERTER stabilizált feszültség, hangszigetelő. EXP OHC felső vezérműtengely motorral. LEADER OHV felső szelepes motorral. MASTER dízel. háromfázisú TRISTAR. A SILENSTAR hangszigetelő. Választható: megszakító 30 mA, elektromos indítás, távoli indítás, automatikus indítás, dugók, átkapcsoló, kocsi, nagy üzemanyagtartály, ...

DESCR. / JEL.	~ (kW)	~	Vol. (L - h)	↗↖ (mm)	Υ (kg)	
<b>ACCESS</b>						
U017006 2200 XL	2,2	1	G	15 - 12	593 × 465 × 458	44
U017007 3400	2,7			3,6 - 3,5	600 × 470 × 415	37
U017008 5000	5,4			6,5 - 4	875 × 570 × 600	70
U017014 5500 XL	5,5			25 - 8	697 × 554 × 549	89
U017009 8000	6,6			6,5 - 3	875 × 570 × 600	75
<b>INVERTER</b>						
U017010 R2000 i	2	1	G	4 - 5	490 × 295 × 445	22
U017011 R3000 i	3			8 - 6	605 × 470 × 525	37
<b>EXP</b>						
U017021 3010 X	2,6	1	G	3,6 - 3,5	600 × 470 × 415	35
U017023 4010 X	3,3			3,6 - 3		38,5
U017025 5010 X	4,3			6,1 - 3	700 × 500 × 485	55
U017027 6010 XL	4,8			12 - 7	785 × 550 × 515	69
U017028 6510 X	5,8			7 - 3,5	790 × 550 × 515	71
U017030 7510 X	7,0			7 - 3	875 × 570 × 600	73

[\*] G = benzina / gasoline / benzin - D = diesel / diesel / dízel

EXP disponibile con serbatoio da 12 o 27 litri / EXP available with 12 or 27 liters fuel tank /  
EXP 12 vagy 27 literes tartállyal kapható

	DESCR. / JEL.	↗ (kW)	~	☑ [*]	Vol. (L - h)	↗↗↗ (mm)	Υ (kg)	
<b>LEADER</b>								
U017016	10500 XL21 DE	9,2	1	G	21 - 6	935 × 570 × 575	99	
U017017	12500 XL21 DE A	10,6			21 - 5		109	
<b>MASTER</b>								
U017043	6010 DXL	↗	5,2	1	D	15 - 10	875 × 535 × 635	96
<b>TRISTAR</b>								
U017050	6510 EX	↗	5,8	1+3	G	7 - 3	810 × 570 × 515	79,5
U017052	8510 EX	↗	7,2			7 - 3	875 × 570 × 600	83,5
U017055	10500 XL DE AVR	10	21 - 6			935 × 575 × 575	118	
U017056	12500 XL DE AVR	12	21 - 5			120		
U017057	6510 DTX	↗	6,3			D	4,5 - 3	910 × 490 × 610
<b>SILENTSTAR</b>								
U017072	6000D MYN	5,2	1	D	22 / 14	860 × 560 × 720	170	
U017073	6500D TYN		1+3					
U017074	7 MAVRYN	6	1	D	40 / 30	1350 × 650 × 840	395	
U017077	7 TAVRYN		1+3					
U017076	13000D MAVRYN	11,3	1	D	40 - 14	1750 × 900 × 1350	570	
U017079	13000D TAVRYN		1+3					
U017080	10 T YN	8	3	D	105 - 52	1750 × 900 × 1350	630	
U017081	15 T YN	12			105 - 28		700	
U017082	20 T YN	16			105 - 26	840		
U017083	33 T YN	26			110 - 18	1900 × 900 × 1500	840	
U017084	44 T YN	35			110 - 14	1000		
U017086	60 T AI	48			200 - 14	2200 × 1100 × 165	1250	
U017087	80 T AI	64			250 - 18	2600 × 1100 × 1650	1460	
U017088	100 T AI	80			250 - 14	1520		
U017089	130 T AI	104			400 - 17	3200 × 1200 × 1900	2100	
U017090	150 T AI	120			450 - 16	2280		
U017091	182 T AI	146	450 - 14	3600 × 1300 × 2050	2680			
U017092	200 T AI	160	450 - 11	2500				

[\*] G = benzina / gasoline / benzin - D = diesel / diesel / dízel

↗ opzione grande serbatoio di carburante 15-22-27 litri (XL) & avviamento elettrico (DE) / option big fuel tank 15-22-27 liters (XL) & electric start (DE) / Választható nagy üzemanyag-tartály 15-22-27 liter (XL) és elektromos indítás (DE)

SILENTSTAR: anche disponibile senza recinzione (OPENSTAR) / also available without enclosure (OPENSTAR) / kapható ház nélkül (OPENSTAR)

### Unità di potenza idraulica

Motore a benzina 7 HP. Strumenti su richiesta.

### Hydraulic power unit

Gasoline engine 7 HP. Tools on request.

### Hidraulikus hajtóegységek

Benzinmotor 7 lóerő. Szerszámok megrendelésre.

	P <sub>max.</sub> (bar)	Q (lpm)	↗↗↗ (mm)	Υ (kg)
U001950	117	20,5	615 × 480 × 590	44

### Pompe per la pulizia dei serbatoi

Pompa mobile, maniglia da 1.8 ... 3,6 m con pennello, tubo flessibile 10 m.

### Tank cleaning pumps

Mobile pump with separator, handle 1.8 ... 3.6 m with brush, hose 10 m.

### Tartálytisztító szivattyúk

Mobil szivattyú elválasztóval, fogantyú 1,8-3,6 m kefével, tömlő 10 m.

	DESCR. / JEL.	Q (m <sup>3</sup> /h)	↗ (kW)	↗ (kW)	Υ (kg)
U012210	Muli 3	3	0,75	↗ 230 V/50 Hz~1	18
U012230	Muli 6	6			
U012240	Muli 12	12	2,2	↗ 400 V/50 Hz~3 (Muli 6 opt. 230 V~1)	30
U012250	Muli 22	22			
U012850	Venturi 192	66	5,6		72

Muli: igirante flessibili / flexible impeller / rugalmas járókerekes





### Detergenti ad alta pressione

Modelli elettrici o con motore. Accessori inclusi.

### High-pressure cleaners

Electric models or with engine. Trolley and accessories included.

### Nagynyomású tisztítók

Elektromos modellek vagy motorral. Tartozékok mellékelve.

📖	DESCR. / JEL.	P <sub>max.</sub> (bar)	Q (lph)	⚡	↗↗↗ (mm)	Υ (kg)
Elettrico, acqua fredda / Electric, cold water / Elektromos, hideg víz						
U002101	HP* 150-9	150	540	230V~1 / 2,7 kW	620 × 600 × 1030	48
Elettrico, acqua calda / Electric, hot water / Elektromos, forró víz [+ 140 °C]						
U003100	<i>su richiesta / on request / kérésre</i>					
Benzina / Gasoline / Benzin						
U003505	HP* 190-10 W	190	600	G / 5,4 HP	620 × 600 × 1030	40
U003510	HP* 150-13	150	780	G / 5,7 HP		
U003520	HP* 200-15	200	900	G / 9,0 HP	700 × 700 × 1060	56
U003530	HP* 250-15	250				68
U003535	HP* 200-21 R	200	1260	G / 14HP	775 × 560 × 720	78
U003540	HP* 300-15	300	900			71

*altri modelli disponibili su richiesta (Kärcher, Kränzle, ...) /  
other models available on request (Kärcher, Kränzle, ...) /  
kérésre más modellek is elérhetők (Kärcher, Kränzle, ...)*

### Turbine ad aria calda

Per riscaldamento di sale e serre, o per scongelamento di attrezzature.

### Hot air turbines

For halls or greenhouses heating, or for equipment defrosting.

### Forrólevegős turbinák

Előcsarnokok vagy üvegházak fűtésére vagy a készülékek leolvasztására.



📖	DESCR. / JEL.	⚡ (kW)	Q (m <sup>3</sup> /h)	ε (kg/h - l)	↗↗↗ (mm)	Υ (kg)
Elettrico / Electric / Elektromos						
R016250	Elektra C 3	3	400	230 V~1	375 × 300 × 340	13
R016255	Elektra C 6	6	1000	400 V~3		
R016260	Elektra C 9	9		230 V~3	445 × 375 × 430	20
R016265	Elektra C 15	15	400V~3			
Diesel, infrarossi / Diesel, infrared / Dízel, infravörös						
R016150	Mini VAL	32,5	-	2,7 - 35	710 × 855 × 810	38
R016151	VAL 6	40	-	3,4 - 40	1200 × 620 × 930	50
Diesel, a combustione diretta / Diesel, direct-fired / Dízel, közvetlen tüzelésű						
R016202	B 70	20,5	410	1,6 - 19	762 × 305 × 381	13
R016203	B 125	40	920	3,0 - 38	900 × 584 × 660	24
R016204	B 350	100	6000	8,5 - 120	1500 × 680 × 100	
Diesel, ventilato / Diesel, vented / Dízel, szellőztetett						
R016211	BV 135	22	1100	1,9 - 3	1250 × 490 × 690	60
R016212	BV 155	31	2600	2,5 - 3	1395 × 635 × 1015	150
R016213	BV 185	54	4500	4,5 - 3	1590 × 725 × 1100	190
R016214	BV 265	70	6300	6,0 - 3	1660 × 725 × 1170	205
R016215	BV 385	110	8200	9,2 - 3	1985 × 895 × 1365	305
R016216	BV 535	150	11000	12,5 - 3	2060 × 915 × 1465	375
R016221	Serbatoio 900 L / Tank 900 L / üzemanyagtartály 900 L					

*controllo modelli diesel / diesel models control / dízel modellek vezérlése : ⚡ 230 V/50Hz~1*

*modelli al propano disponibili su richiesta / propane models available on request /  
propán modellek megrendelésre kaphatók*

☞ *riscaldamento dell'acqua e regolazione della temperatura a pagina 73-78  
water heating and temperature regulation pages 73-78  
vízmelegítés és hőmérséklet-szabályozás a 73-78. oldalon*